



**AUTOMATIC MARSHALL
STABILITY MACHINE
TMB-1710**

MANUAL USER

www.testmak.com

Automatic Marshall Stability Machine

1	GENERAL INFORMATION	3
1.1	GENERALITIES	3
1.2	IDENTIFICATION	3
1.3	APPLICATIONS	3
1.4	STRUCTURE AND OPERATING OF THE MACHINE	4
2	SAFETY INFORMATION	5
2.1	GENERAL SAFETY INFORMATION	5
2.2	DANGEROUS PARTS AND RESIDUAL RISK	5-6
2.3	NOISE	6
3	INSTALLATION	7
3.1	LIFTING	7
3.2	UNPACKING	7
3.3	INSTALLATION	7
3.4	ELECTRIC CONNECTIONS	8
4	MACHINE FEATURES	9
5	OPERATOR'S INTERFACE	9
6	MACHINE USE	10
6.1	WARNINGS	10
6.2	SWITCHING ON THE APPLIANCE	10
6.3	TOOLING UP	10
6.4	PROGRAMMING THE CONTROL PANEL	11
6.5	PROCEDURE FOR THE OPENING OF THE SAFETY GUARDS	11
6.6	EMERGENCY STOP	11
6.7	STARTING AFTER AN EMERGENCY STOP	11-12
6.8	START TEST	13
6.9	TEST MENU	14-17
7	MAINTENANCE	18
7.1	PERIODICAL INSPECTIONS	18
8	DIAGNOSIS	18
8.1	DIAGNOSIS	18
9	ELECTRIC SHEME	19

Automatic Marshall Stability Machine

1. GENERAL INFORMATION

1.1 GENERAL FEATURES

- ✂ This manual is addressed to the carrier, the installer, the user, the maintenance operator, the scrapping operator.
- ✂ Please read it carefully because it informs you about the operating of the machine in safety conditions.
- ✂ This manual has to be considered a part of the product and concerns only the machine it is delivered with.
- ✂ Keep the manual in order during the whole life of the appliance to consult it for any needs.
- ✂ In case of sale, the manual and its enclosures should be given together with the machine.
- ✂ The TESTMAK assumes no liability for any damages caused by a misuse of the machine.
- ✂ The TESTMAK has the right to modify this technical literature as well as the machines this refers to without any previous notice.
- ✂ Messages meaning:

ATTENTION : It shows the procedures that can damage seriously the machine if they are not followed carefully.

DANGER : It shows the procedures that can be dangerous to the operator if they are not followed carefully.

1.2 IDENTIFICATION

TESTMAK : TESTMAK INS.LAB.MAK.SAN.VE TİC. PAZ. İTH. İHR. LTD. STİ

Trademark: TESTMAK

Country of Origin : TURKEY

Product name: MARSHALL STABILITY TEST MACHINE

Code of product: TMB-1710

1.3 APPLICATIONS

The Testmak Marshall Stability machine is a motorised load frame specifically designed to carry out Marshall Stability tests. It is a bench-mounted system with a motorised drive. The speed is pre-set to 50.8 mm/min which covers both ASTM and BS standards. Additional items required to perform the test such as load cell, linear potentiometric displacement transducer, mould parts etc. are supplied as part of the Marshall Stability load frame.

Ensure that shipment is stored under suitable conditions. Water and excessive humidity can cause oxidation and therefore damage to the machine.

Take note of any handling instructions on the packaging. Ensure that machine is stored the correct way up. Remove all packaging and protection from the shipment. Check that all parts of the machine are free from damage. If any parts appear to be damaged do not switch on or operate the machine. Refer to Testmak for advice and local repair facilities. Ensure that all documentation and manuals that may be included inside the packaging are retained. The Testmak Marshall Stability machine is a 50 kN load frame fitted with a single speed AC motor.

ATTENTION

The instructions given in this operating manual are only made for the right use of the appliance. To carry out the test in the right way, the user must refer to the specific standards in force for the test itself.

Automatic Marshall Stability Machine

2. SAFETY INFORMATION

2.1 GENERAL SAFETY INFORMATION

- ✂ The use, lifting, installation, maintenance and scrapping of the machine are allowed only to qualified staff. A qualified staff is composed by people who are authorised by the safety responsible to do any activities due to their experience and acknowledgement of the operating of the machine and of the standards, rules and actions.
- ✂ The user must be carefully taught about he operating of the machine to avoid any misuse of it and about the safety devices, which the machine could be eventually equipped with. The safety devices will have to be kept always assembled and to be daily checked.
- ✂ The TESTMAK offers training and assumes no liability for any damages due to a misuse of the machine by an unskilled staff.
- ✂ The TESTMAK recommends following carefully the instructions and procedures of the operating manual and the safety standards concerning the safety devices and the general rules of the work environment.
- ✂ Verify the accordance of the machine to the standards in force in the state where the machine has to be installed.
- ✂ The operating manual must be carefully read by the safety responsible, by the operators and maintenance engineers. It must always be kept near the machine in order to be able to read it any times it will be necessary.
- ✂ Any tampering or modifications of the machine (electric, mechanical etc.) that are not allowed by a written agreement of the TESTMAK must be considered as not permitted and the TESTMAK will not accept to be charged for any damages.
- ✂ The removal or the tampering of the safety devices will be an infringement to the EEC Safety Standards. The TESTMAK assumes no liability for any damages.
- ✂ The machine has to be installed in places safe from fire and explosions.
- ✂ TESTMAK do recommend using only original spare parts and accessories; on the contrary the TESTMAK assumes no liability.
- ✂ Be careful that any dangerous situations won't happen during the working; stop immediately the machine in the event that it will not work properly and ask the TESTMAK or the Authorised Service Staff of the dealer at once.

2.2 DANGEROUS PARTS AND RESIDUAL RISK

The dangerous place is the space inside and around the machine where the operator could be wounded or damaged. During some procedures the operator could face some risks of danger. The risks can be eliminated following carefully the procedures written in this manual and using suitable safety devices.

ATTENTION

In case the machine installation is not done by the TESTMAK, employ only skilled operators particularly trained for the lifting of heavy machinery.

Automatic Marshall Stability Machine

GENERAL INFORMATION

- ✔ Before starting the standard use of the equipment, ensure that all the components are in good working conditions check there are no defective or damaged parts. If necessary repair or replace any damaged part.
- ✔ Do not wear large clothes, ties, kettles, watches or others, which could entangle in the frame as well as in any moving part of the machine.
- ✔ Pay attention to the risk for electric shocks both direct and indirect, due to a failure to the electric system.
- ✔ Do not subject the appliance to impacts or shocks.
- ✔ Do not expose the appliance to fire, extreme temperatures or weld splatter.
- ✔ Avoid corrosive substances to come in touch with the appliance.
- ✔ Do not wash the machine using water spray.

DURING THE USE

- ✔ In order to grant the maximum security level for the operator, do not touch any moving part of the appliance during the test execution and wear the convenient protection devices.
- ✔ If the appliance is not equipped with safety guards, do not stand nearby during the test execution. Do not attempt to operate the equipment with covers removed.
- ✔ If the appliance is provided with safety guards, pay attention to the risk of finger squeeze when closing the same.

DURING THE LIFTING

- ✔ During the lifting take care that the machine is conveniently held and secured and that it cannot slide.
- ✔ Do not stand in a direct line with the application of force. Do not allow people entrance under loads that are no conveniently supported by mechanical means.

2.3 NOISE

Please read this entire manual before unpacking, setting up or operating this equipment. Pay attention to all danger and caution statements. Failure to do so could result in serious injury to the operator, or other personnel, or damage to the equipment.

DANGER

The continuous use of the machine together with other noisy appliances could cause a high level of exposure to the noise. If the daily exposure of the operator is equal or higher than 85 dB(A), Safety Devices as headphone are suggested to be worn. If the daily exposure is equal or higher than 90 dB(A), the use of the Safety Device is compulsory. For further information consult the standards of the country where the machine has been installed.

Automatic Marshall Stability Machine

3. INSTALLATION

3.1 LIFTING

The operating instructions must be respected during:

- ✂ The lifting and the storing
- ✂ The first installation
- ✂ The further installations

The machine is usually packed in a wooden case to be moved by a forklift. During the lifting of the case, it is recommended to take the utmost care and to follow the lifting directions labelled on the case. If possible, use forklift or crane and fasten the case with belts and ropes, avoid the use of chains.

ATTENTION The lifting of the case must be effected with great care and following the lifting directions on the case.

ATTENTION Protect the machine from the atmospheric agents. Water and humidity could oxidise it, damaging it seriously.

3.2 UNPACKING

After removing the package, check that any parts of the machine are not damaged. In case of doubt, DO NOT USE THE MACHINE and ask the TESTMAK.

DANGER The materials used for the package (plastic, polystyrene, screws, nails, wood etc.) have to be kept far from children. They must be thrown away in a proper collection centre.

ATTENTION Before throwing away the package, pay attention that any accessories, manuals, documents, spare parts are not inside.

3.3 INSTALLATION

The machine has to be placed in an environment suitable for the aim it has been conceived in laboratory. The installation must be done by skilled operator.

ALLOWED TEMPERATURE	from + 5°C to + 40°C
ALLOWED HUMIDITY	from 30% to 95%
MIN. HEIGHT	2500 mm

Automatic Marshall Stability Machine

4. MACHINE FEATURES

TMB-1710 Technical Specifications	
Capacity	50 kN
Platen Speed	50.8 mm/min.
Dimensions	400x560x1100 mm
Weight (approx)	95 kg
Power	1100 W

5. OPERATOR'S INTERFACE

1	Main cabinet, housing all the mechanics and electronics
2	Strain rods (column)
3	Lift Plate
4	Cross beam
5	Table Clamp
6	Digital Control Unit
7	Load Cell 50 kN
8	Penetration Piston
9	Plastic Sleeve
10	Linear Potentiometric Displacement Transducer, 25x0.001 mm with bracket
11	Marshall Stability Mould
12	Computer Connect Port for software

Automatic Marshall Stability Machine

6. MACHINE USE

6.1 WARNINGS

Before starting the normal use of the equipment it is recommended to verify that it is in good working conditions with no defective or damaged parts. If necessary proceed with the required maintenance operations.

Before starting a test the user must check the main features of the materials composing the specimen and try to foresee the way it will react to the compaction test in order to use the proper cautions.

6.2 SWITCHING ON THE APPLIANCE

Before starting the normal use of the equipment it is recommended to verify that it is in good working conditions with no defective or damaged parts. If necessary proceed with the required maintenance operations.

Before starting a test the user must check the main features of the materials composing the specimen and try to foresee the way it will react to the compaction test in order to use the proper cautions.

ATTENTION Before switching on the appliance ensure it is connected to the power net.

To operate the machine, firstly switch on the power.

The machine is fitted with electronic limit switches in both directions. This prevents the user from damaging the machine or motor as the platen will automatically STOP when the limit of travel is reached.

The speed of the Marshall machine is pre-set to 50.8 mm per minute. This speed is not changeable.

6.3 TOOLING UP

Here under we describe the proper procedure to allow tooling up the appliance correctly even to an operator without a wide experience.

ATTENTION The TESTMAK assumes no liability for any damage caused by an incorrect use of the appliance.

1	To operate the machine, firstly switch on the power.
2	Place the sample in the stability mold.
3	Check test value on the digital panel screen
4	Push "START" button for start test.

Automatic Marshall Stability Machine

6.4 PROGRAMMING THE CONTROL PANEL

The control panel is configured by the TESTMAK in the test values; in case you realize that the configuration is incorrect and not suitable to the machine features, contact the After Sale Service immediately.

NOTE If you want to change the settings, follow the procedures below.

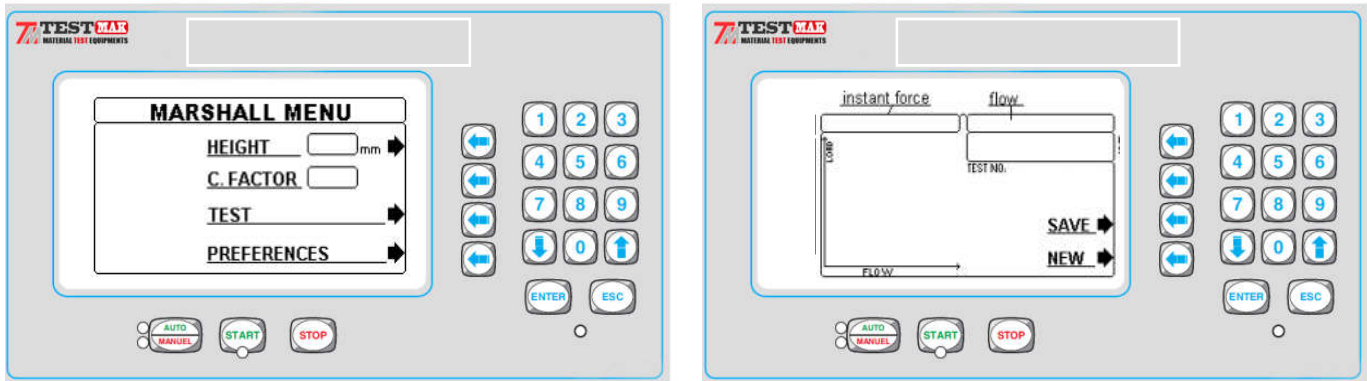

1	You can write new values with number on keyed.
S2	Write the measured height, correction factor is calculated automatically.
S3	Press the Arrow key for save.

6.5 PROCEDURE FOR THE OPENING OF THE SAFETY GUARDS

The Marshall stability machine can only work when the safety guard is closed and locked by the special lever. In case the emergency button is pushed during the test running, the Marshall stability machine will automatically stop. In this case the test values would be lost.

If the operator needs to stop the Marshall stability machine at any time and to open the safety guards. Pushing the key the appliance will automatically stop, the stroke counter is reset. It is worth reminding that the test interruption causes its annulations.

Before switching on the appliance once again, find and solve the problems, which caused the need for an emergency stop.

6.6 EMERGENCY STOP

In case of emergency it is possible to stop the test execution at by positioning the emergency button on "0"

6.7 STARTING AFTER AN EMERGENCY STOP

Before switching on the appliance once again, find and solve the problems, which caused the need for an emergency stop. To switch the appliance again, just move the "emergency button", placed on the Control Panel, to position "I", this will reset appliance normal functions.

Automatic Marshall Stability Machine

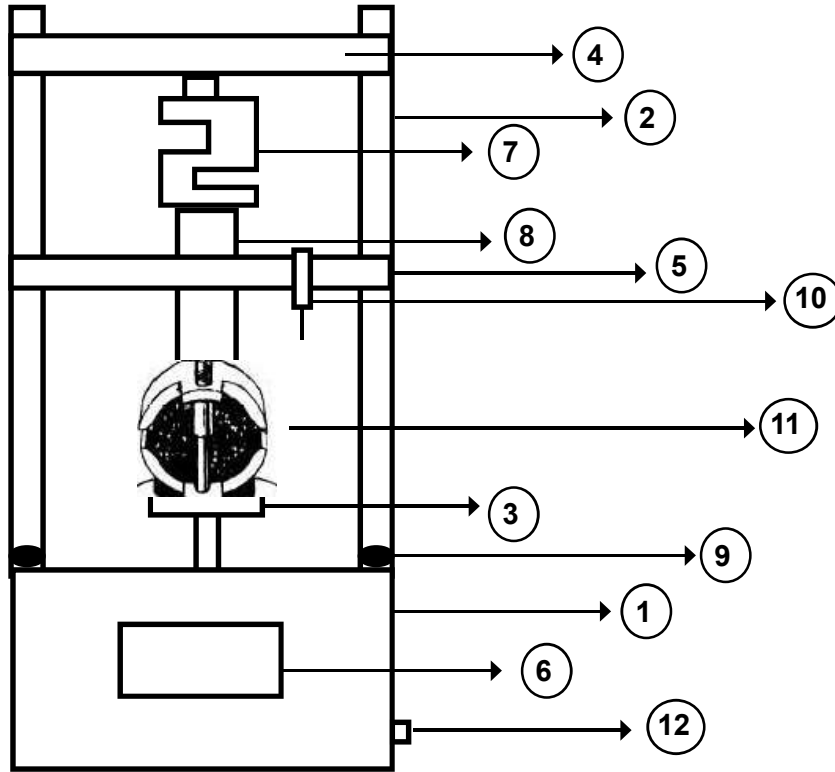

Figure 3: Marshall Stability Machine Assembly

Marshall Stability Machine Assembly (Refer to figure 3)

- (1) Main cabinet, housing all the mechanics and electronics
- (2) Strain rods (column)
- (3) Lift Plate
- (4) Cross beam
- (5) Table Clamp
- (6) Digital Control Unit
- (7) Load Cell 50 kN
- (8) Penetration Piston
- (9) Plastic Sleeve
- (10) Linear Potentiometric Displacement Transducer, 25x0.001 mm with bracket
- (11) Marshall Stability Mould
- (12) Computer Connect Port for software

NOTE You can check page 9 for details.

Automatic Marshall Stability Machine

6.8 START TEST

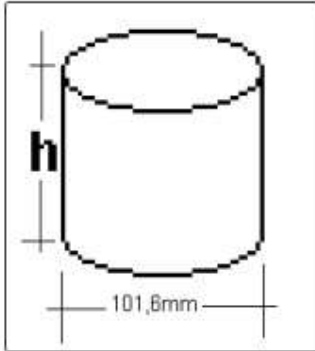

Measure the height of the compacted asphalt "h". Correction factor is defined in the ASTM D1559.

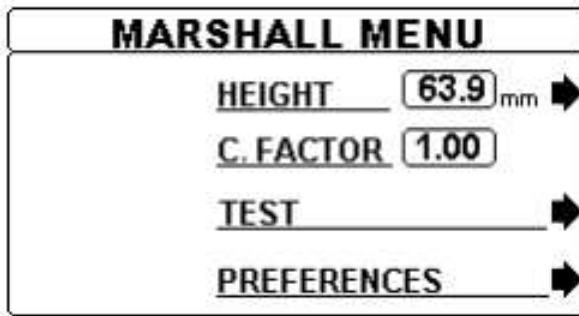

Write the measured height, correction factor is calculated automatically.
Press test key.

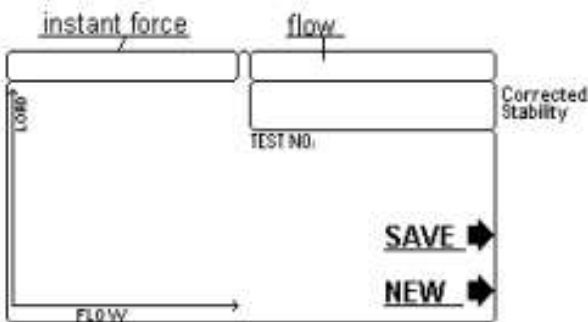

Test screen shown on the left. If the compacted asphalt has been put in their place, press 'START' key. While test is continued; instant force, instant flow and instant corrected stability displayed.

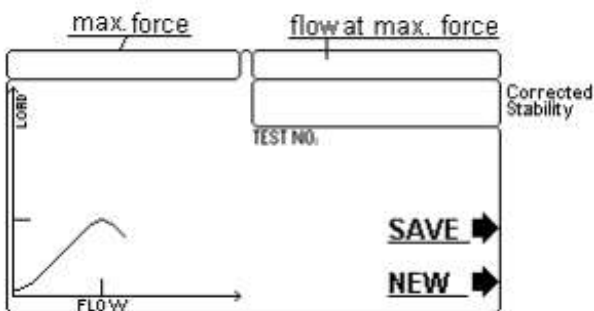

After the test is finished; maximum Force, flow att maximum Force and Corrected stability are displayed.

Automatic Marshall Stability Machine

6.9 TEST MENU

PREFERENCES MENU

MARSHALL MENU

HEIGHT 63.9 mm

C. FACTOR 1.00

TEST

PREFERENCES

Left picture shows the main screen.
Press the "PREFERENCES" key with arrow key.

PREFERENCES

LANGUAGE - FORCE UNIT

LOAD RATE

FRACTURE SENSING

STARTING FORCE

DATE-TIME

ARCHIVE

CALIBRATION

ABOUT

SELECT TEST

Preferences screen.
Load rate is not active for marshall test.

PREFERENCES/LANGUAGE - FORCE UNIT:

LANGUAGE - UNITS

TURKISH

ENGLISH

kN

kgf

To change language; press the related key then press "ENTER" to accept, or press "ESC" to cancel the selection.* kgf may not be active.

Automatic Marshall Stability Machine

PREFERENCES/FRACTURE SENSING:

FRACTURE SENSING

% of maximum force

▲
▼

if the 60 is selected; maximum force 800 kN, if the force drops below $800 \times \%60 = 480\text{kN}$, fracture is detected, and the test is ended .Optimum value is %75.

PREFERENCES/STARTING FORCE:

STARTING FORCE

N
 CHANGE ▶

The smallest load required to understand that pcm304 loading begins.

PREFERENCES/TEST ARCHIVE :

TEST ARCHIVE

EVALUATION DATE ▶

TEST NUMBER ▶

PCM304 can test can test automatically, the user can register the test result. computer. To see the test result in PCM304 memory; enter evaluation date or test number then pres ENTER.

ARCHIVE		Prev ▲	Next ▼
Test Number			
Date			
Specimen			
Diemension			
Force			
Strength			

Left picture shows the test result screen. To see next/previous test use Up/Down key

Automatic Marshall Stability Machine

PREFERENCES / CALIBRATION:

PREFERENCES
FRACTURE SENSING
STARTING FORCE
DATE-TIME
ARCHIVE
CALIBRATION
ABOUT
SELECT TEST

Use up and down key, find the CALIBRATION and press "ENTER".

PASSWORD
<input type="text"/> ENTER THE KEY

Enter the password (2277) and press enter.

SELECT CHANNEL
CHANNEL 1 →
CHANNEL 2 →
CHANNEL 3 →
CHANNEL 4 →

Select the channel you want to calibrate. for 50 kN Marshall stability machine press the CHANNEL1 key.

CHANNEL 1
<input type="text"/> CAPACITY →
5 POINTS CAL. →
1 POINT CAL. →
Force → kN
Distance → mm
Temperature → C

If the capacity window is blank, write on it your machine full force capacity. 50 kN or 100 kN. Then press 5 or 1 point calibration.

Automatic Marshall Stability Machine

1 POINT CALIBRATION:

CALIBRATION POINTS		
1.	0 kN	CHANGE →
2.	25 kN	
		OK →

Cal. value	Ok	Cal. count
0		
2500		

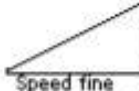

Speed fine

↑4

↓7

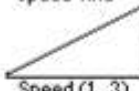

Speed (1, 3)

↑6

↓9

SAVE - EXIT →

The first point is 0 kN, the second point default value is half of the full capacity. The second point does not have to be at full capacity. If you want, you can change the second calibration point. Press the CHANGE key and write the new value by using numeric keys, and press enter. If calibration points are ok then press OK.

This is the calibration screen. To start the calibration press START Zero calibration value is automatically received.

To increase the engine speed press "6" (fine speed "4"), to decrease the engine speed press "9" (fine speed "7"). To stop the engine press "2", to run again press "3". To get the second point value : Set the engine speed, when your calibration indicator shows "2500 N" press the "ENTER" key. If it is ok, press "SAVE-EXIT" key

5 POINT CALIBRATION:

CALIBRATION POINTS		
1-	0 kN	CHANGE →
2-	10 kN	
3-	20 kN	
4-	30 kN	
5-	40 kN	
6-	50 kN	OK →

Cal. value	Ok	Cal. count
0		
000000		
0		
1000		
2000		
3000		
4000		
5000		

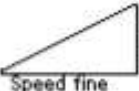

Speed fine

↑4

↓7

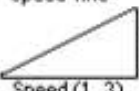

Speed (1, 3)

↑6

↓9

SAVE - EXIT →

The 5-point calibration values are shown in the illustration on the right.

To change any value press CHANGE key.

Use the up and down keys to scroll to the line you want to change. Write the new value then press ENTER . If calibration points are ok then press OK.

This is the calibration screen.

To start the calibration press START Zero calibration value is automatically received.

To increase the engine speed press "6" (fine speed "4"), to decrease the engine speed press "9" (fine speed "7").

To stop the engine press "2", to run again press "3".

To get the second point value : Set the engine speed, when your calibration indicator shows "5000 N" press the "ENTER" key. Repeat this for other points.

If all calibration points are complete, press "SAVE-EXIT" key.

Automatic Marshall Stability Machine

7. MAINTENANCE

DANGER

All the maintenance operations must be carried out with the machine turned off and unplugged from the knife switch.

DANGER

Skilled operators instructed about the purposes the machine is made for must carry any kind of maintenance operations concerning the components of the machine and of the electric components, even those that may seem very simple.

DANGER

Only original spare parts are allowed. The TESTMAK assumes no liability in the event that non original parts are used.

DANGER

Only original spare parts are allowed. The TESTMAK assumes no liability in the event that non – original parts are used

7.1 PERIODICAL INSPECTIONS

Under normal operation the machine does not require any special maintenance, as all parts are maintenance free. All that is required is to keep the machine in the conditions specified at the beginning of this handbook and to ensure that it is not accidentally damaged in any way. Periodically clean the machine and oil parts that are not painted. Do not use solvents, which may damage the paint and made of synthetic materials.

If the machine is to be stored and not used for any length of time disconnect the electricity supply, oil the parts that are not painted and cover the machine to protect it from dust. Should you experience any problems with your machine please contact your local distributor or Testmak factory.

8. DIAGNOSIS

8.1 DIAGNOSIS

Some easy to solve and simple problem, which can happen during the working of the appliance, are introduced in this chapter.

ATTENTION

All maintenance, checking, control and repairing operations of each part of the machine or of the electric system, must be carried out by skilled operators instructed about the functions and working procedures of the appliance.

Automatic Marshall Stability Machine

9. ELECTRIC SCHEME

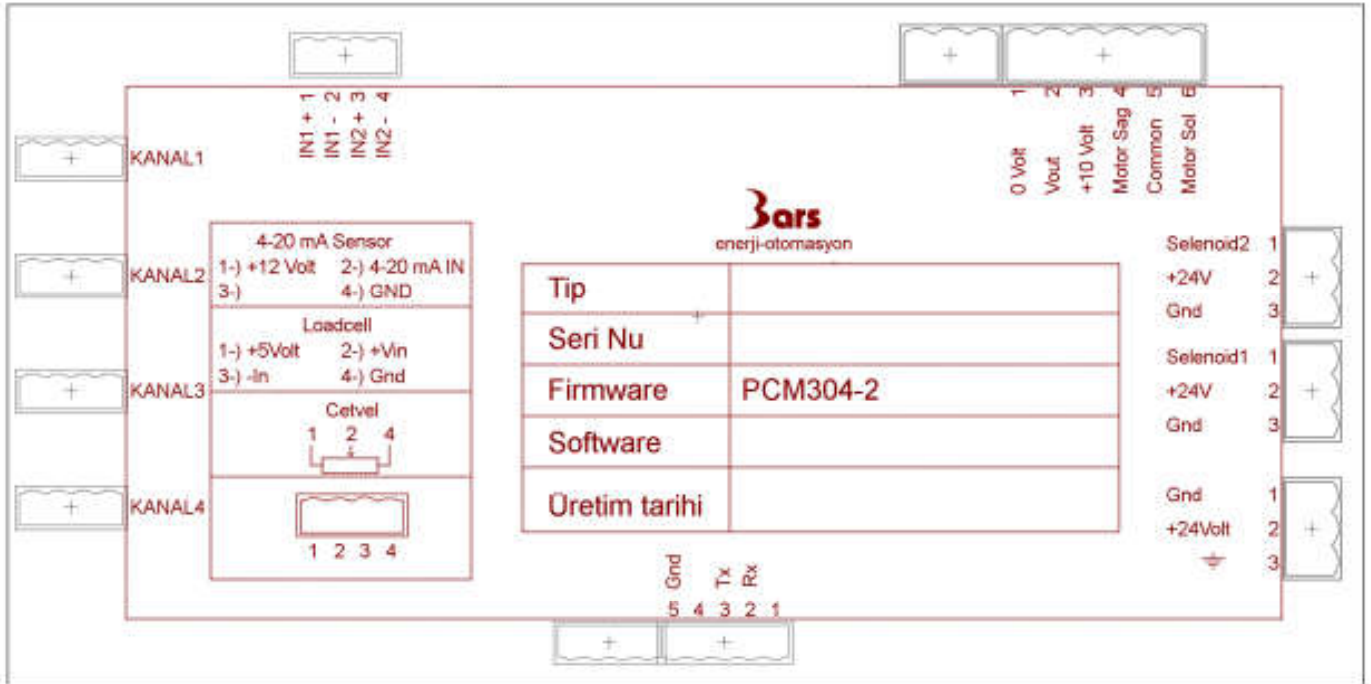



TESTMAK
MATERIAL TEST EQUIPMENTS

Telephone : +90 312 395 36 42
Fax : +90 312 395 36 43

www.testmak.com
info@testmak.com

Koca Sinan Industrial Sites 1183 Street No:
40 06370 OSTIM / ANKARA / TURKEY